

(12)

EUROPEAN PATENT APPLICATION

(21) Application number: 88402701.2

(51) Int. Cl. 4: **H 04 N 7/16**

(22) Date of filing: 26.10.88

(30) Priority: 26.10.87 US 113017
 (43) Date of publication of application:
 03.05.89 Bulletin 89/18
 (64) Designated Contracting States:
 AT BE CH DE ES FR GB GR IT LI LU NL SE

(71) Applicant: **ACTV, INC.**
 4 Manhasset Avenue
 Port Washington New York 11050 (US)
 (72) Inventor: **Freeman, Michael J.**
 31 Cornwall Lane
 Stands Point New York 11050 (US)
 (74) Representative: **Thevenet, Jean-Bruno et al**
 Cabinet BEAU DE LOMENIE 55 rue d'Amsterdam
 F-75008 Paris (FR)

(54) Closed circuit television system having seamless interactive television programming and expandable user participation.

(57) A closed circuit interactive television system (10) provides a multichannel television signal from a localized head end (12) which is used for individualized interactive selections by a plurality of users (22, 24, 26). Each user station contains a conventional television receiver (32a, 32b, 32c) and a smart box or interface and selection device (30). The smart box or interface and selection device (30) is disposed between the television receiver (32) and the RF distribution amplifier (36). The number of user stations (22, 24, 26) on the system (10) is virtually unlimited. The system (10) provides the audio/video television signals (14, 16, 18, 20) in at least frame accurate synchronization to enable seamless video switching between channels, which seamlessness is enhanced through the view of a pair of tuners in the interface selection box (30a, 30b, 30c) which are alternately commanded to pretune to the channel of the next actual choice made prior to the changeover under control of a microprocessor in response to command signals embedded in the television signals being received.

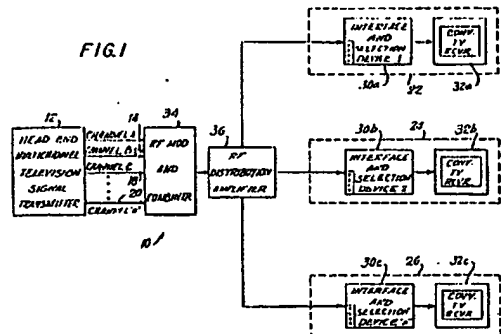

EP 0 314 572 A2

Description**Closed Circuit Television System Having Seamless Interactive Television Programming And Expandable User Participation**5 CROSS REFERENCE TO RELATED APPLICATIONS

This application is related to previously issued U.S. Patents Nos. 4,507,680 entitled "One Way Interactive multisubscriber Communication System"; 4,573,072 entitled "Method for Expanding Interactive CATV Displayable Choices for a Given Channel Capacity"; 4,602,279 entitled "Method for Providing Targeted Profile Interactive CATV Displays" 4,264,924 entitled "Dedicated Channel Interactive Cable Television System", and 10 4,264,925 entitled "Interactive Cable Television System", the contents of all of which are specifically incorporated by reference herein in their entirety, and is an improvement thereon to enable the provision of discrete closed circuit interactive television systems, such as for training or educational purposes, as opposed to a larger scale cable television or broadcast system such as described in the aforementioned related patents.

15

TECHNICAL FIELD

The present invention relates to interactive television communication systems and particularly to closed circuit television systems for providing seamless interactive television programming with unlimited expandability of usership.

20

BACKGROUND ART

Real time conversational student response teaching apparatus are known, such as described in U.S. Patents Nos. 3,947,972 and 4,078,316. In addition, multiple choice student response systems are well known, such as exemplified by the system disclosed in U.S. Patents Nos. 2,921,385 ; 3,020,360 ; 2,826,828, 3,623,238 ; 25 3,546,791 ; 3,273,260 ; 3,665,615 ; 3,245,157 ; 3,284,923 ; 3,538,621 ; 3,477,144 ; 3,708,891 ; 3,255,536 ; 2,777,901 ; 2,908,767 ; 3,774,316 ; 3,194,895 ; 3,484,950 ; 3,343,280 , and 3,763,577 by way of example. None of these Prior Art systems, however, has been adapted to be employed in a closed circuit interactive television system having seamless interactive television programming in what appears to be a two-way interactive network in which the individualized television programming information to be received by the individual users 30 of such a training or educational system may be independently displayed on a common program display channel of a conventional television in response to independent user selection from a multichannel television signal. Moreover, although prior art cable television systems are known in which a plurality of unrelated television programs, under control of a computer, are transmitted over a common television channel for selection by the individual subscribers, such as disclosed in U.S. Patents Nos. 3,814,841 and 3,757,225, such systems are not one way interactive systems capable of independent subscriber selectable reception of simultaneously transmitted multi-information television programming for providing a closed circuit television system having seamless interactive television programming independently displayable on a common program display channel. Furthermore, although U.S. Patents Nos. 4,624,924 ; 4,624,925 ; 4,507,680, 4,573,072; and 4,602,279 are all interactive television systems, they are primarily directed to mass audience cable or broadcast television systems as opposed to a discrete localized closed circuit television system capable of readily providing seamless interactive television programming. Such local education television programming has generally previously been provided through video disc or compact disc searching systems and methods with inherent disadvantages such as requiring one video disc per user with visible rather than seamless branching due to the time required to search and locate an upcoming branch. Moreover, such systems are quite costly, generally cannot run for a great length of time, can only be used by one user at a time and require 45 each user to have a complete system of a player, a video disc and a computer. These disadvantages of the prior art are overcome by the present invention.

DISCLOSURE OF THE INVENTION

50 The present invention relates to a closed circuit discrete multichannel interactive television system for providing individualized interactive television programming to an expandable plurality of users connected into the closed circuit interactive television system in which switching between individualized television signals in a multichannel television signal transmitted from a head end occurs in a seamless manner for enabling display on a common program display channel of a given user interactive selection on an associated conventional television receiver via an interface and selection device, or smart box, connected between the television receiver and the head end. The head end is a multichannel television signal transmitter, such as a multiplexed video player or a plurality of single video players for continuously transmitting a multichannel television signal. 55 The multichannel television signal transmission comprises a plurality of different interactively selectable audio/video television signals which are at least in frame accurate synchronization with respect to each other and contain command signals embedded therein for controlling provision of the individualized television programming on the common program display channel. The interface and selection device is responsive to the embedded command signals for enabling the aforementioned switching between the individualized television signals in a substantially instantaneous seamless interactive television display presentation having invisible 60

branching (searching). Different television receivers in the system are capable of displaying different individualized television signals on the common program display channel at substantially the same time dependent on the various independent interactive user selections for the plurality of users at any given time. The interface and selection device may include a microprocessor and a pair of television signal tuners for pretuning the associated television receiver to a television signal frequency corresponding to the next individualized television signal for display on the associated television receiver common program display channel dependent on the user selection before an actual change in the television display on the common program display channel occurs in response to the independent user interactive selection for maintaining seamlessness on the television display despite interactive changes in the television signal selected for display from the multichannel television signal. If desired, the capability of the interactive television programming provided on the closed circuit interactive television system of the present invention may be expanded through the use of stacking of the available responses to be selected. In addition, the system is transparent to the number of users connected to it and may readily be expanded by merely connecting a conventional television receiver to the system via an interface and selection device.

BRIEF DESCRIPTION OF DRAWINGS

- Fig. 1 is a block diagram of the overall presently preferred closed circuit interactive television system in accordance with the present invention ;
- Fig. 2 is a block diagram of a typical presently preferred interface and selection device, or smart box, in accordance with the present invention, for use on the system of Fig. 1 ;
- Fig. 3 is a schematic diagram, partially in block of a typical presently preferred selector board portion of the interface and selection device of Fig. 2 ; and
- Fig. 4 is a schematic diagram, partially in block, of a typical presently preferred control board or microprocessor control portion of the interface and selection device of Fig. 2.

BEST MODE FOR CARRYING OUT THE INVENTION

Referring now to the drawings in detail, and initially to Fig. 1 thereof, the presently preferred closed circuit interactive television system in accordance with present invention, generally referred to by the reference numeral 10, is shown. The closed circuit television system 10 preferably provides a plurality, preferably four by way of example, of audio/video television signals in at least frame accurate synchronization from a head end multichannel television signal transmitter 12, with four such channels labeled "A" 14, "B" 16, "C" 18 and "n" 20 being shown by way of example in Fig. 1. Preferably, all of these television signals 14, 16, 18, 20 are continuously transmitted to the plurality of users in the closed circuit interactive television system 10 which may readily be expanded to include any desired number of users, with "n" such users being represented in Fig. 1 by the three user stations 22, 24 and 26 in Fig. 1. As shown and preferred in Fig. 1, and as will be described in greater detail hereinafter, each user station 22, 24, 26 preferably includes a conventional RF demodulator 28a, 28b, 28c, respectively, an interface and selection device or smart box 30a, 30b, 30c, respectively, and a conventional television receiver 32a, 32b, 32c, respectively, which may preferably receive the desired interactive television programming on a common program display channel, such as channel 3, which is preferably an unused channel for normal television broadcast so that the television receiver 32a, 32b, 32c may also receive conventional television broadcast. This becomes particularly important in a classroom environment where the television receiver 32a, 32b, 32c is normally used to receive localized television programming created in the school as well as outside conventional television broadcasts as part of the educational instruction in the classroom. In this regard, the presently preferred closed circuit interactive television system 10 of the present invention readily lends itself to such uses as localized educational system for schools, localized training systems, localized control of marketing displays, localized where the head end 12 is located in one room in the building and the users distributed gambling systems in hotels, etc., by way of example, throughout the building as opposed to the mass audience systems provided by conventional cable television networks.

As further shown and preferred in Fig. 1, the audio/video television signals 14, 16, 18, 20 which are preferably provided simultaneously in frame accurate or better synchronization, may be provided to the various users as a multiplexed multichannel television signal from conventional RF modulators 34 and a combiner via a conventional RF distribution amplifier 36 having as many output ports as students or users connected on the system 10. Users may readily be added or subtracted from the closed circuit interactive television system 10 merely by adding or removing another typical user station 22, 24 or 26. To do thus, assuming a user is to be added to the system 10, the user need only add a smart box or interface and selection device 30 between a conventional television receiver 32 and one of the output ports of the RF distribution amplifier 36. On the system 10 itself is transparent to the number of users 22, 24 or 26 on the system 10, which provides an unlimited expansion of users with no additional headended hardware or software.

Preferably, each smart box or interface and selection device 30 takes commands, only from the particular channel the associated user is on, from command signals embedded in the audio/video television signals being transmitted from the head end 12 (or can be on the audio subcarriers) and can switch or change between the multiple channels being transmitted. Since the multiple channels in the multichannel television signal being transmitted from the head end are preferably in frame accurate synchronization or better, such switches appear to be seamless, that is the television display never freezes or goes blank, and are essentially

instantaneous. As will be described in greater detail hereinafter, preferably the interactive television program being transmitted from the head end 12 is made in such a way as to anticipate possible switches or branch changes and to design the camera shots and audio so that each change will match each other similar to the way a conventional television edit matches. In this manner, the user or viewer would therefore see a seamless television program that contains regular camera cuts as well as camera cuts that also create branches, which means that in addition to a camera cut the channel may also change, such as illustrated by way of example below in Table A :

Table A

	<u>Channel A</u>	<u>Channel B</u>	<u>Channel C</u>	<u>Channel "n"</u>
15				
20	Camera shot is wideshot Thank you for indicating your education level.	Nothing is on this channel at this point	Nothing is on this channel at this point	Nothing is on this channel at this point.
30	Cut to close up camera shot	Cut to close up camera shot	Cut to close up camera shot	Cut to close up camera shot
35				
40	I can see from your answer that you never fi-	I can see from your answer that you are a high school graduate. I'll	I can see from your answer that you are a college gradu- ate. I'll re-	I can see from your answer that you have done graduate work. I'll re-
45	nished high school. I'll remember this and refer	remember this and refer to it later	member this and refer to it later.	member this and refer to it later.
50	to it later.			

55 Preferably, in creating the above interactive television programming, the most likely branch is the one that is shot through on a continuous basis. As a result, most of the time camera angle changes are not necessary for a likely branch.

60 With respect to the head end 12, the source of the prerecorded television signals for the desired interactive television programming can be conventional four 1/2 inch VHS machines, 3/4 inch video tape machines, 1 inch professional machines, video disc players run on synch as opposed to search, or a single tape source that is multiplexed down to hold four separate signals, such as the alternate field and alternate frame approach. The wire or connection from the head end 12 to the various smart boxes or interface and selection devices 30, may preferably be coaxial cable, fiber optics, or direct baseband video and audio, by way of example.

65 Referring now to Figs. 2-4, a typical preferred smart box or interface and selection device 30 is shown. As

shown and preferred in Figs. 2-4, the interface and selection device is preferably a microprocessor 40 based device that receives all of the transmitted television signals, such as four in the above example, and can preferably instantaneously switch between all four signals only letting one through to the associated television receiver 32. As shown in Fig. 4, which is a detailed schematic of the microprocessor or control board 40 portion of the system 10, the control board 40 has logic, intelligence, and memory. In addition, as shown and preferred, a pair of conventional tuners 44, 46 are provided in interface and selection device 30 each of which can tune to the one of the plurality, or 4 by way of example, of signals which it wishes to receive and pass through to the associated television receiver 32. Preferably, the second television tuner 46 is provided to enhance the seamlessness of the system 10. Thus, since conventional television tuners may not be able to tune to one of the other television frequencies fast enough to maintain the seamlessness of the system 10, the second tuner 46 is provided which preferably returns to the proper television frequency that the microprocessor 40 tells it will be the next channel it will be changing to. This preferably happens microseconds before the actual change but this is enough to maintain seamlessness. The first tuner 44 would then be instructed to pretune to the next change that is coming up. Thus, the tuners 44 and 46, which are conventional such as available from Sanyo, and which preferably each comprise an RF section 50a, 50b, respectively and a demodulator section 52a, 52b, respectively alternate in pretuning the channel to the television frequency of the next channel under control of the microprocessor 40 and tuner control 160. The interface and selection device 30 also preferably includes a conventional vertical interval synch detector 54 which detects the vertical synch in the received television signal so as to enable the change or switching between channels at the vertical interval to, once again, enhance seamlessness. The actual switch between tuners/demodulators is accomplished by conventional video switch 42 and conventional audio switch 41. In addition, an input selector 56, such as a four button keypad is provided either independently or on the smart box 32 for enabling the interactive selection of a plurality of different user interactive choices or responses during the interactive programming being transmitted from the head end 12. The input selector is either wired directly to the smart box or communicates via an infrared communication link. In addition, conventional joysticks sensors, buttons and the like may also be employed as user input devices.

Preferably, as previously mentioned, embedded in the various television signals, are instrumentation codes that instruct the smart box 30 in switching, memory, logic and computational codes, such as the manner of coding explained by way of example, in U.S. Patent No. 4,507,680, the contents of which are incorporated by reference herein in their entirety. The codes, as described in U.S. Patent No. 4,507,680, are preferably embedded on line 21 and the video signals are decoded by decoder 43 to provide this command information to the microprocessor 40. The smart box 30 preferably only requires the codes that exist on the various television channels it passes through to its associated television receiver 32. It will, thus preferably, not receive, and will ignore, the embedded codes on the other channels. Of course, for each user in the system 10, the resulting code stream is likely to be different because the combinations of the different channels they see will likely be different.

Thus, the presently preferred system 10 has instant invisible branching because the branches come from one of the other three channels that are already in frame accurate synchronization with the source channel. The interactive television programming used with the system 10 is preferably designed so that the channel the user is on will always cut or edit match any other channel the user might change to in the interactive television transmission. This is preferably similar to how an edit is performed in post production video except that in that instance the video will always be on the same channel. Thus, in effect, the present invention 10 is a real time dynamic editing system that creates innumerable combinations and versions of the program based on how the channels are switched, which, in turn, depends on the selections made by the user in conjunction with the corresponding smart box commands.

The system 10 of the present invention may incorporate any of the features set out in any of the aforementioned patents incorporated by reference herein, such as stacking, which is described by way of example in U.S. Patent No. 4,573,072. Suffice it to say that four channels, for example, do not limit the system 10 to only four outcomes. Stacking can increase this number to 6,9 or even more. Stacking provides time delays in responses. Such time delays, which are invisible to the user since program material or filler is created on one of the channels, allow for branching to be expanded to more alternatives than the number of available channels. For example, with one channel as filler, six possible outputs can be given ; and if this channel filled 2 time slots, then 9 outputs could be given, such as illustrated below in Table B :

Table B

5	CHANNEL 1	DIALOGUE	DIALOGUE FILLER	DIALOGUE FILLER
	2	OUTPUT 1	OUTPUT 4	OUTPUT 7
10	3	OUTPUT 2	OUTPUT 5	OUTPUT 8
	4	OUTPUT 3	OUTPUT 6	OUTPUT 9

15

In addition to the above, annexed hereto as Table C is an example of a typical script for an interactive television program in accordance with the present invention.

20 By utilizing the system of the present invention, a discrete closed circuit multichannel interactive television system is provided, having instantaneous invisible branching between interactively selected choices, and which is readily expandable through the use of a smart box and a conventional television.

25

30

35

40

45

50

55



60

65

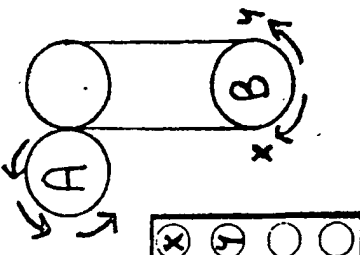
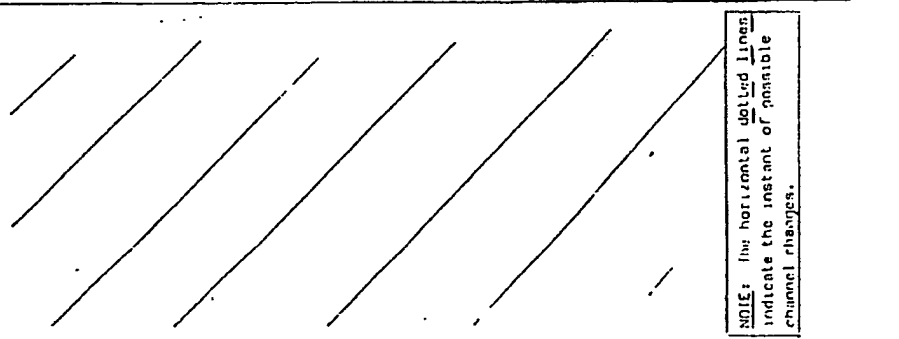
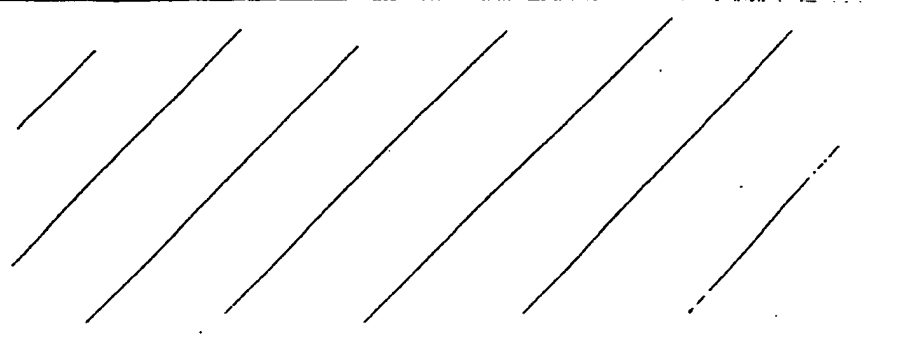
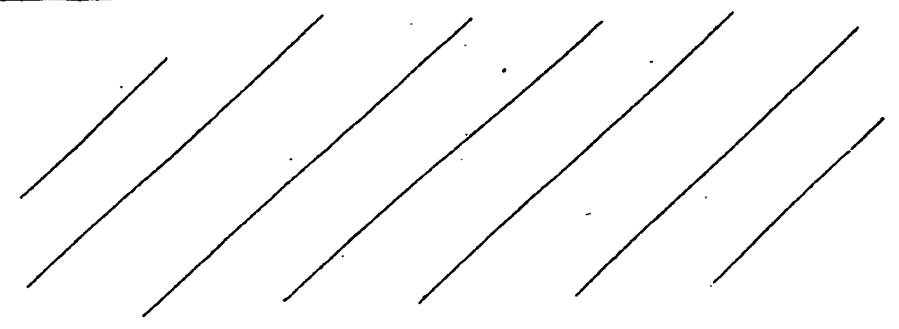
ACTUAL SCRIPT EXAMPLE

CHANNEL 1	CHANNEL 2	CHANNEL 3	CHANNEL 4
<p>Let's do some training. These are called Pulley Problems, and they always appear on the college board exams:</p>  <p>Now, if wheel A is moving in the direction indicated, in which direction would wheel B move? Answer either "X" or "Y" -- you've got seven seconds. So answer either X or Y.</p> <p>COMPUTER COMMANDS: If viewer selects X, then stay on Channel 1; if viewer selects Y, then go to Channel 2; if viewer selects an unlabeled button, then go to Channel 3; or, if viewer fails to answer, then go to Channel 4.</p> <p>You have answered...</p>			

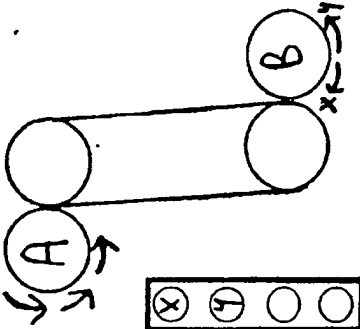
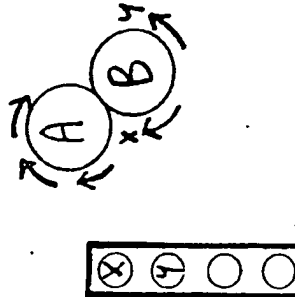
NOTE: The horizontal dotted lines indicate the instant of possible channel changes.

CHANNEL 1	CHANNEL 2	CHANNEL 3	CHANNEL 4
<p>...Direction X -- good work! Tracing through it, we can see that you are right. So let's give you a more difficult pulley problem for the next one:</p> 	<p>...Direction Y, and I'm sorry -- that's wrong. Tracing through it, you can see that wheel B should move in Direction X. Since you answered that one wrong, let's try an easier pulley problem:</p> 	<p>...by pushing an unlabeled button, so I would have to score you wrong. Tracing through, you can see that wheel B should move in Direction X. I'd better give you an easier pulley problem; this time, please follow the instructions.</p> <p>(Same diagram as on Channel 2.)</p> 	<p>...too late. You only had seven seconds, so I'll have to mark you wrong. You see, if wheel A moves this way, then wheel B should move in Direction X. I think I'd better give you an easier pulley problem. But this time, try to answer more quickly please:</p> <p>(Same diagram as on Channel 2.)</p> 
<p>If wheel A is moving in the direction indicated, in which direction would wheel B move this time? Answer either Direction X, or Direction Y. You have six seconds -- Direction X or Direction Y.</p> <p>COMPUTER COMMANDS: If the viewer selects X, then go to Channel 2. If the viewer selects Y, then stay on Channel 1. If the viewer selects an unlabeled button or fails to answer, then go to Channel 2.</p>	<p>If wheel A moves in the direction indicated, in which direction would wheel B move? You have six seconds. Answer either Direction X, or Direction Y.</p> <p>COMPUTER COMMANDS: If the viewer selects X, then go to Channel 4. If the viewer selects Y, then go to Channel 3. If the viewer selects an unlabeled button or fails to answer, then go to Channel 4.</p>	<p>If wheel A moves in this direction; in which direction does wheel B move? You have six seconds. Answer either Direction X or Direction Y.</p> <p>COMPUTER COMMANDS: If the viewer selects X, then stay on Channel 4. If the viewer selects Y, then go to Channel 3. If the viewer selects an unlabeled button or fails to answer, then stay on Channel 4.</p>	<p>Wheel A moves in this direction; in which direction does wheel B move? You have six seconds. Answer either Direction X or Direction Y.</p> <p>COMPUTER COMMANDS: If the viewer selects X, then stay on Channel 4. If the viewer selects Y, then go to Channel 3. If the viewer selects an unlabeled button or fails to answer, then stay on Channel 4.</p>

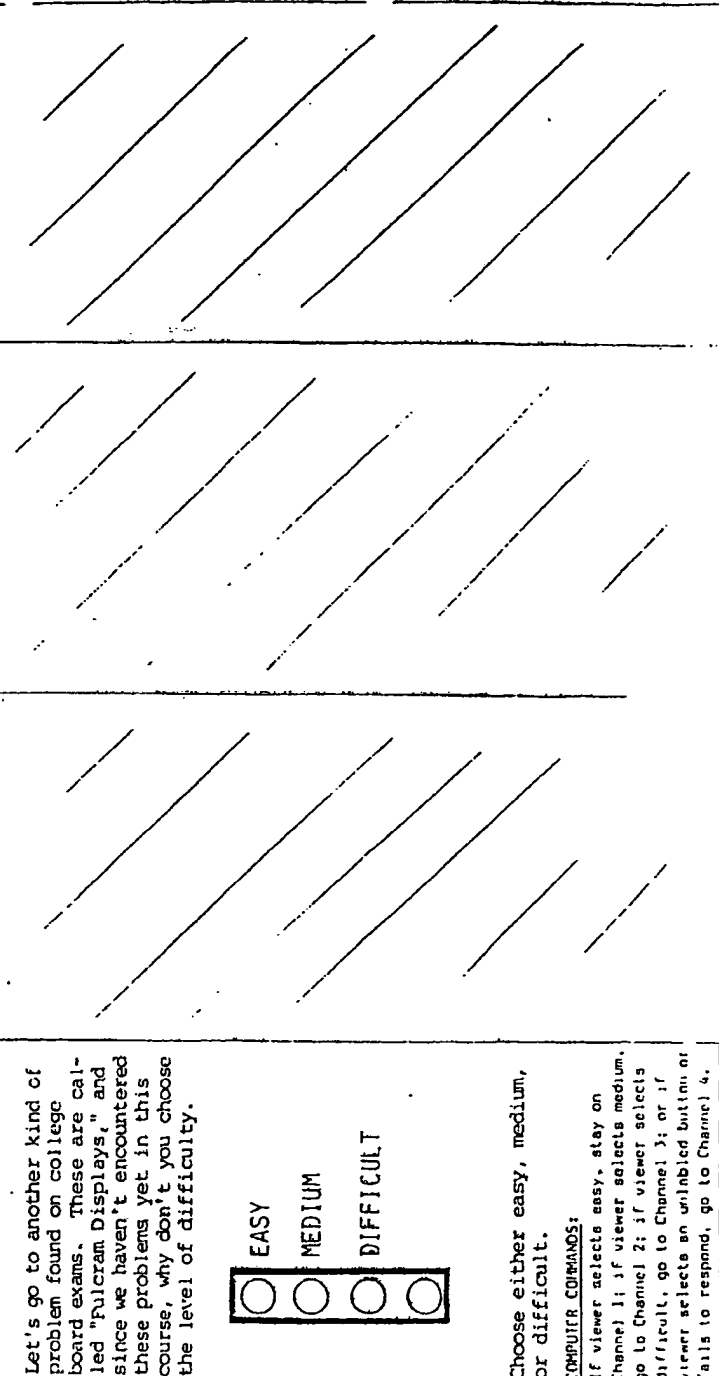
CHANNEL 1	CHANNEL 2	CHANNEL 3	CHANNEL 4
<p>You've answered Direction Y. That's right -- good work! You're really good at these! Let's trace through it together: Wheel A moves in that direction; Wheel B moves in Direction Y.</p> <p>(Stay on Channel 1.)</p> <p>Let's go to another kind of problem found on college board exams. These are called "Fulcrum Displays," and since we haven't encountered these problems yet in this course, why don't you choose the level of difficulty.</p> <div style="border: 1px solid black; padding: 5px; margin: 10px 0;"> <p style="text-align: center;"> <input type="radio"/> EASY <input type="radio"/> MEDIUM <input type="radio"/> DIFFICULT </p> </div> <p>Choose either easy, medium, or difficult.</p> <p>COMPUTER COMMANDS: If viewer selects easy, stay on Channel 1; if viewer selects medium, go to Channel 2; if viewer selects difficult, go to Channel 3; or if viewer selects an unabled button or fails to respond, go to Channel 4.</p>	<p>You have answered Direction X, and I'm sorry -- but you're wrong this time. Tracing through, you can see that the correct answer would be Direction Y.</p> <p>(Automatic switch to Channel 1.)</p>	<p>You have answered Direction Y. Good work -- you're improving! If Wheel A moves in this direction, then Wheel B moves in Direction Y.</p> <p>(Automatic switch to Channel 1.)</p>	<p>You have answered X, and you are wrong again! Now, this is a very easy problem; watch, and I'll show you. Wheel A moves in this direction, then Wheel B moves in Direction Y.</p> <p>(Automatic switch to Channel 1.)</p>
			

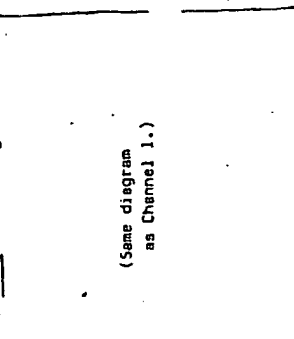
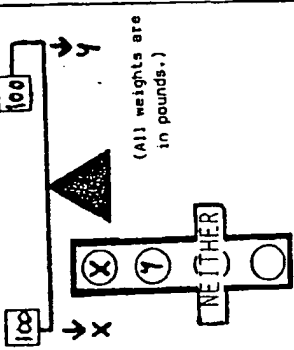
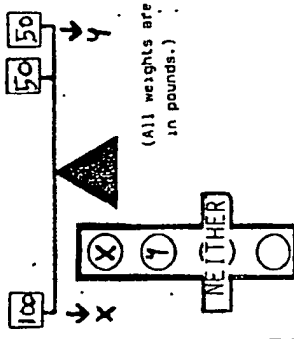
CHANNEL 1	CHANNEL 2	CHANNEL 3	CHANNEL 4
<p>OK, let's do the <u>easy</u> question.</p>  <p>(All weights are in pounds.)</p>	<p>OK, let's do the <u>medium</u> question.</p>  <p>(All weights are in pounds.)</p>	<p>OK, let's do that <u>difficult</u> one!</p>  <p>(All weights are in pounds.)</p>	<p>OK, I see that you've made some error, so I'll choose the <u>easy</u> one for you.</p> <p>(Same diagram as Channel 1.)</p>
<p>If the weights were placed on this see-saw as indicated which side would go down: X or Y? Please answer either X, Y, or neither if you think the weights would balance. This time you'll only have five seconds.</p>	<p>If the weights were placed on this see-saw as indicated, which side would go down: Side X, or Y? Please indicate your answer -- X, Y, or neither if you think they'd balance. You only have five seconds.</p>	<p>If the weights were placed on this see-saw as indicated, which side would go down? Answer either X, Y, or neither if you think they'd balance. This time you have five seconds.</p>	<p>If the weights were placed on this see-saw as indicated which side would go down? Answer either X, Y, or neither if you think they'd balance. You have five seconds.</p>
<p>COMPUTER COMMANDS: If viewer selects X, then stay on Channel 1. If the viewer selects Y, neither, an unlabeled button, or fails to answer, go to Channel 4.</p>	<p>COMPUTER COMMANDS: If the viewer selects X, then stay on Channel 2. If the viewer selects Y, neither, an unlabeled button, or fails to answer, then go to Channel 4.</p>	<p>COMPUTER COMMANDS: If the viewer selects X, then stay on Channel 3. If the viewer selects Y, neither, an unlabeled button, or fails to answer, then go to Channel 4.</p>	<p>COMPUTER COMMANDS: If the viewer selects X, then go to Channel 1. If the viewer selects Y, neither, an unlabeled button, or fails to answer, then go to Channel 4.</p>

CHANNEL 1	CHANNEL 2	CHANNEL 3	CHANNEL 4
<p>You are right -- X would go down. And even though this was an easy question, it's still good work.</p> <p>COMPUTER COMMANDS: If the viewer answered both pulley problems wrong, or answered the first pulley problem wrong, then go to Channel 1. If the viewer answered the first pulley problem wrong and the second pulley problem right, then go to Channel 2. If the viewer answered both pulley problems right, then go to Channel 3.</p> <p>Well, that's all the time we have for today. Now, in reviewing your performance I can see that although you had trouble with the pulley problems, you did get the Fulcrum Display problem right. The appropriate program for you on this system would be the intermediate program.</p> <p>(Automatic switch to Channel 4.)</p>	<p>You are right -- X would go down. And even though you chose the medium question, this is still good work.</p> <p>Well, that's all the time we have for today. Now, in reviewing your performance I can see that although you got the first pulley problem wrong, you did get the easier one right, and the Fulcrum Display problem right. The appropriate program for you on this system would be the intermediate program.</p> <p>(Automatic switch to Channel 4.)</p>	<p>You are right -- X would go down. And since you chose the difficult question, this is especially good work.</p> <p>Well, that's all the time we have for today. In reviewing your performance, I see that you got both pulley problems and the Fulcrum Display problem right. Congratulations -- that's perfect performance! The appropriate program for you on this system would be the advanced program.</p> <p>(Automatic switch to Channel 4.)</p>	<p>You are wrong. X would go down. Now, at this point I would explain the principles behind Fulcrum Display problems, and then I would give you a group of remedial ones to go through. In addition, shows like these can keep track of your cumulative progress, and at the end of each program, I can review your overall performance.</p> <p>COMPUTER COMMANDS: If the viewer answered both pulley problems incorrectly, then go to Channel 1. If viewer answered one pulley problem wrong and the other right (in either order), then go to Channel 2. If the viewer answered both pulley problems correctly, then go to Channel 3. (Switch to Channel 1, 2, or 3, as indicated above.)</p>
<p>In this program you missed both the pulley problems and the Fulcrum Display problem. This is not good performance. The appropriate program for you on this system would be the beginning program. Good day.</p>	<p>In this program you had mixed results with regard to the pulley problems, and you missed the Fulcrum Display problem. The appropriate program for you on this system would be the intermediate program. Good day.</p>	<p>In this program, although you got both the pulley problems right, you did miss the Fulcrum Display problem. The appropriate program for you on this system would be intermediate program. Good day.</p>	<p>Thanks for joining me -- have a nice day.</p> <p>(Closing filter.)</p>

END

END

END

END

Note: In the above script, all camera shots were designed so that the resulting show appears continuous and seamless to the user, no matter which allowable branch path was taken.

Claims

5

1. A closed circuit discrete multichannel interactive television system for providing individualized interactive television programming to a plurality of users connected into said closed circuit interactive television system (10), characterized in that said system comprises a localized head end multichannel television signal transmission means (12), a plurality of conventional television receiver means (32a, 32b, 32c) for selectively receiving individualized television programming on a common program display channel, and an interface and selection means (30a, 30b, 30c) disposed between each of said television receiver means (32a, 32b, 32c) and said localized head end multichannel television signal transmission means (12) for receiving said transmitted multichannel television signal and converting it into an individualized television signal for display on said common program display channel on the television receiver means associated with a given user making an independent interactive user selection in response to said independent user selection of a given interactive response to a plurality of selectable interactive responses in said multichannel television signal transmission, each of said users having an associated television receiver means (32a, 32b, 32c) and interface and selection means (30a, 30b, 30c) for making said independent interactive user selection for providing said individualized television programming on said common program display channel, said multichannel television signal transmission comprising a plurality of different interactively selectable audio/video television signals (14, 16, 18, 20) in at least frame accurate synchronization with respect to each other, said interactively selectable television signals (14,16,18,20) further comprising command signals embedded therein for controlling provision of said individualized television programming on said common program display channel, said interface and selection means (30a, 30b, 30c) being responsive to said embedded command signals for enabling switching of said individualized television signal for display on said common program display channel between said plurality of interactively selectable television signals in a substantially instantaneous seamless interactive television display presentation on said common program display channel of said associated television receiver means, different television receiver means (32a, 32b, 32c) in said system being capable of displaying different individualized television signals on said common program display channel at substantially the same time dependent on the various independent interactive user selections of said plurality of users at any given time.

2. A closed circuit interactive television system in accordance with claim 1 characterized in that said interface and selection means (30) comprises a microprocessor means (40) and a television signal tuner means (44,46), said microprocessor means (40) responding to said individualized independent user interactive selection and said embedded command signals for pretuning said associated television receiver means to a television signal frequency corresponding to the next individualized television signal for display on said associated television receiver means common program display channel dependent on said independent user selection before an actual change in said television display on said common program display channel occurs in response to said independent user interactive selection; whereby said seamlessness is maintained for said television display on said common program display channel despite interactive changes in said television signal selected for display from said multichannel television signal.

3. A closed circuit interactive television system in accordance with claim 1 or claim 2 characterized in that said plurality of different selectable television signals (14,16,18,20) in said multichannel television signal comprise a plurality of edit matched individualized television signals, whereby the television frequency said conventional television means is tuned to at any given time will edit match into any other television frequency said television means is subsequently tuned to in response to a change in said user selection.

4. A closed circuit interactive television system in accordance with claim 3 characterized in that one of said edit matched individualized television signals comprises a source channel television frequency and said other edit matched individualized television signals comprise different branch channel television frequencies being in frame accurate synchronization with said source channel television frequency; whereby instant vertical interval invisible branching may be provided in response to different user selections.

5. A closed circuit interactive television system in accordance with claim 4 characterized in that said plurality of different selectable television signals (14,16,18,20) including said source channel comprises four.

6. A closed circuit interactive television system in accordance with claim 1, characterized in that one of said individualized television signals comprises a source channel and said other television signals in said plurality of different selectable television signals comprise different branch channels, said different branch channels being in frame accurate synchronization with said source channel; whereby instant invisible branching may be provided in response to different user selections.

7. A closed circuit interactive television system in accordance with claim 6 characterized in that one of said edit matched individualized television signals comprises a source channel television frequency and

said other edit matched individualized television signals comprise different branch channel television frequencies being in frame accurate synchronization with said source channel television frequency ; whereby instant invisible branching may be provided in response to different user selections.

8. A closed circuit interactive television system in accordance with any one of claims 4 to 7 characterized in that said source channel comprises the most likely response in a plurality of selectable responses for said user during said television transmission.

5

9. A closed circuit interactive television system in accordance with any one of claims 1 to 8 characterized in that said multichannel television signal is continuously transmitted to said plurality of conventional television receiver means during a given program interval.

10. A closed circuit interactive television system in accordance with any one of claims 1 to 9, characterized in that said transmitted multichannel television signal comprises a sequence of a plurality of different multichannel television message stacks, each stack comprising a plurality of time concurrent multichannel television messages, said plurality of stacks comprising a stacking array, said stacking array providing a plurality of selectable time and space multiplexed complete prerecorded television messages from said head end (12), said array being transmitted in said closed circuit system (10) to said interface means (30a, 30b, 30c), a single substantially complete television message being interactively selectable from said array in response to said user selection for providing an interactive television message as said individualized television signal to said conventional television receiver means (32a, 32b, 32c) in said interface means (30a, 30b, 30c), the quantity of available interactively selectable prerecorded television messages in said array being greater than the quantity of available different television signals, said array comprising a television programming sequence having an interactively variable program information content for a given television program, said interface means comprising means for interactively selecting a multichannel message path through said array for providing said television programming sequence program information content, said interactive selection being multiplexed in both time and space in said array said interface means (30a, 30b, 30c) selecting said message path through said array in response to a single interactive selection, a different interactive selection providing a different message path through said array and a different program information content for said television programming sequence.

10

15

20

25

11. A closed circuit interactive television system in accordance with claim 10 characterized in that said program content for said given television program further comprises a common prerecorded television message commonly displayable during said given television program irrespective of any interactive selections of said interactively selectable television messages.

30

12. A closed circuit interactive television system in accordance with claim 11 characterized in that each of said complete television messages in said array comprising said television programming sequence comprises a segway portion for providing an information transition between said common television message and said television programming sequence, said television programming sequence and said common television message being adjacent in real time in a given television program.

35

40

45

50

55

60

65

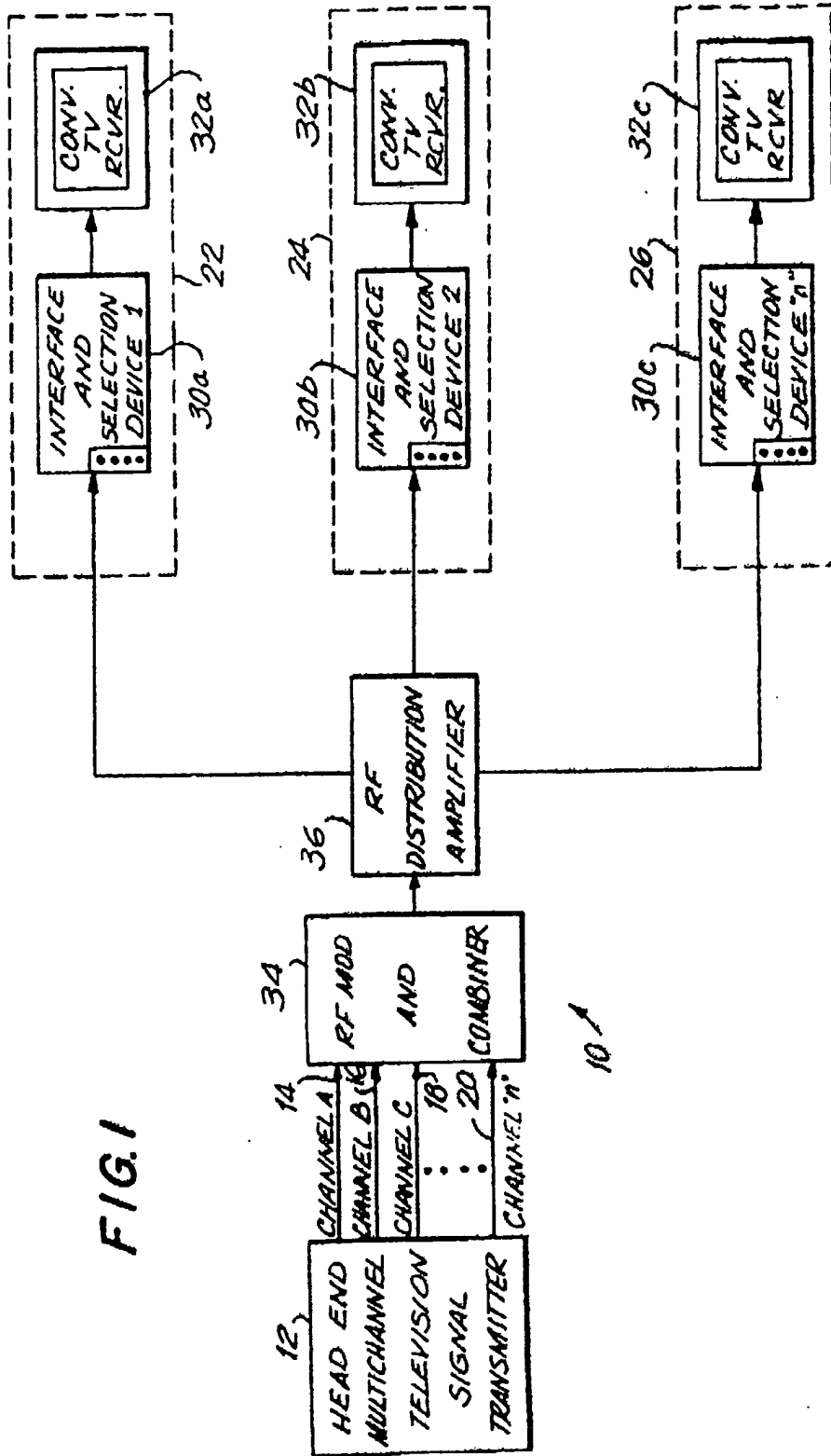

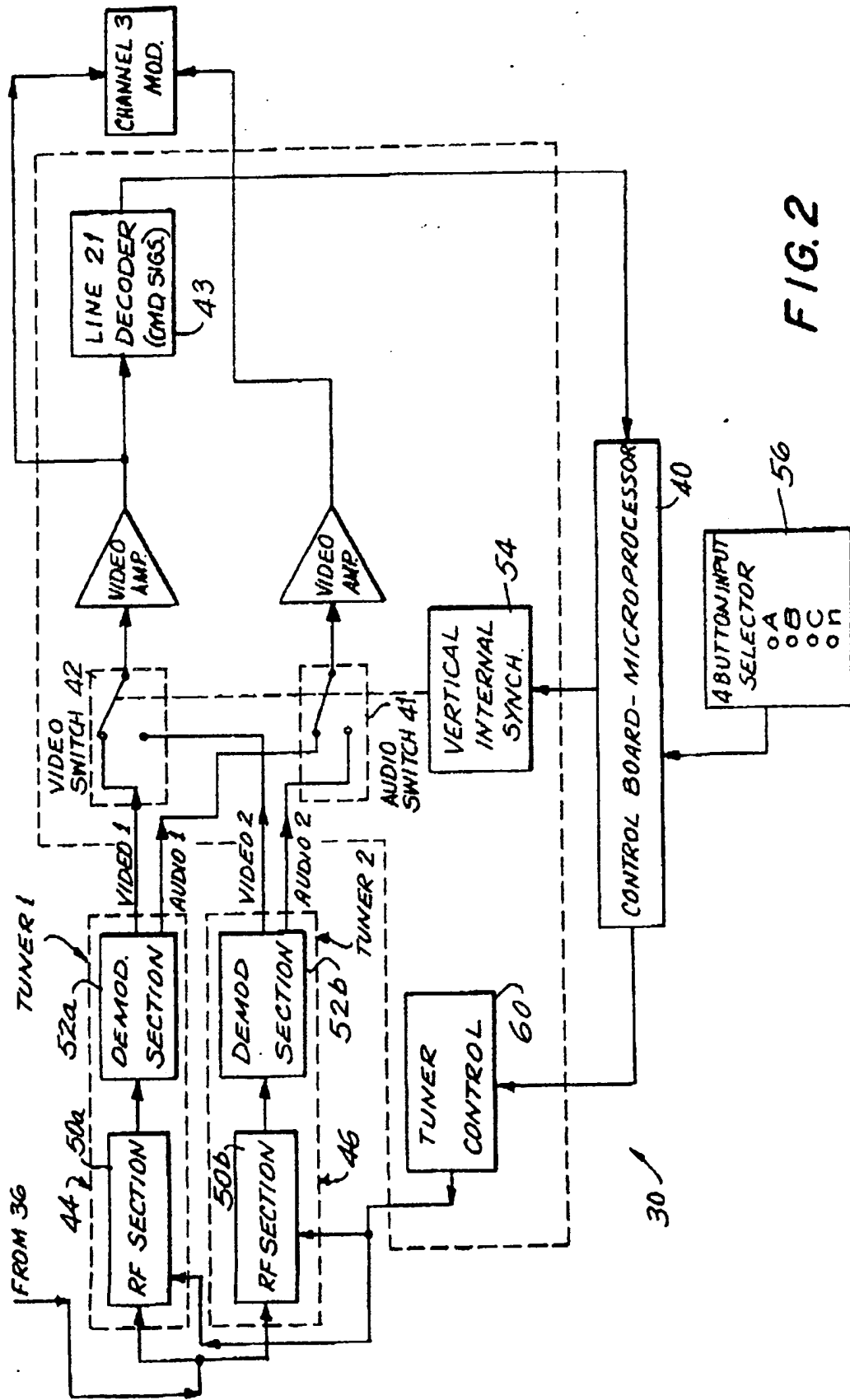

FIG. 2

FIG. 3

FIG.	FIG.	FIG.
3A	3B	3C

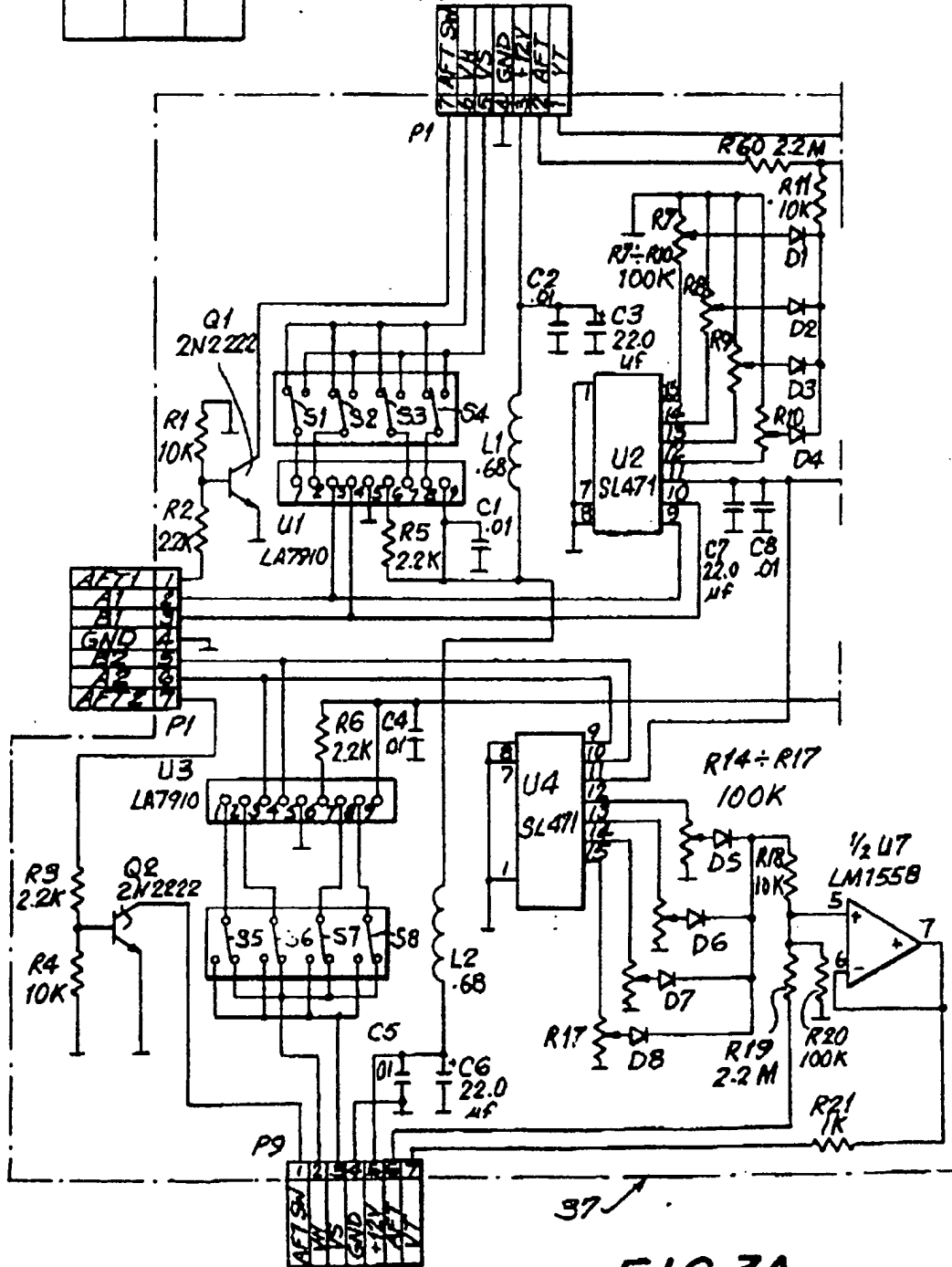
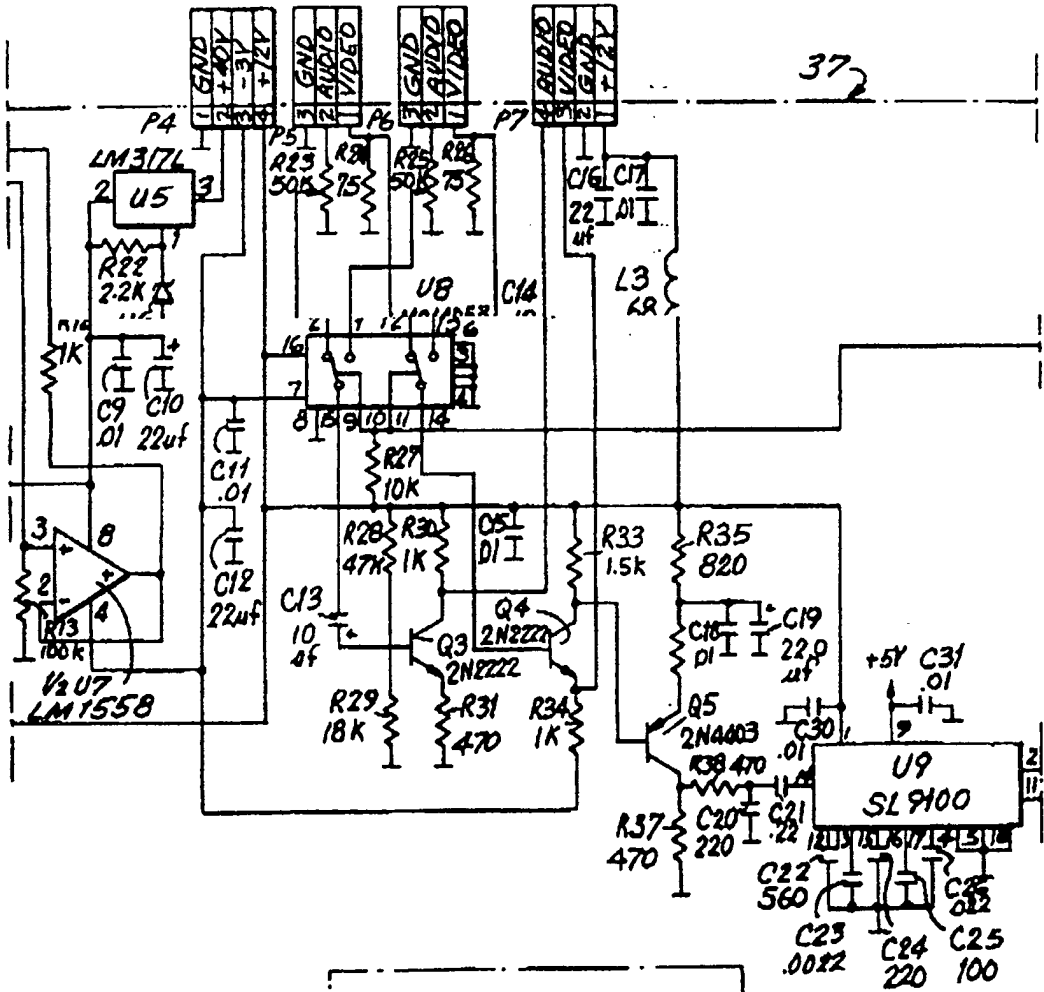

FIG. 3A

FIG. 3B



DESIGNATION	
LAST	UNUSED
C36	--
L3	--
P9	--
S8	--
Q7	--
X1	--
U16	--
D14	D9
R60	R32, 42, 51 THRU 58



FIG. 3C

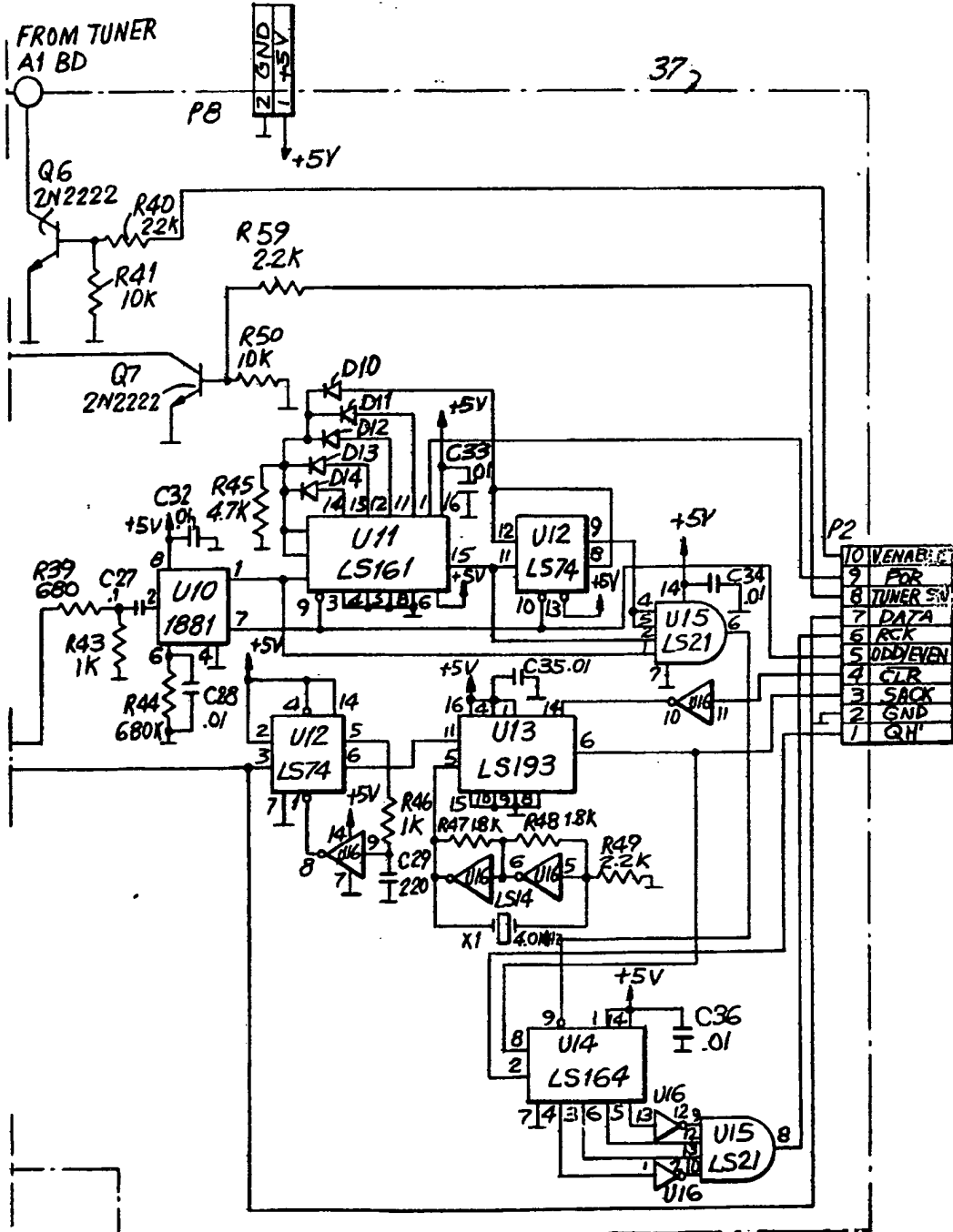

FIG. 4

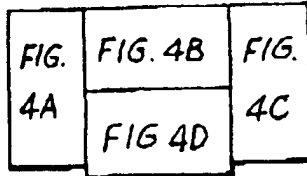
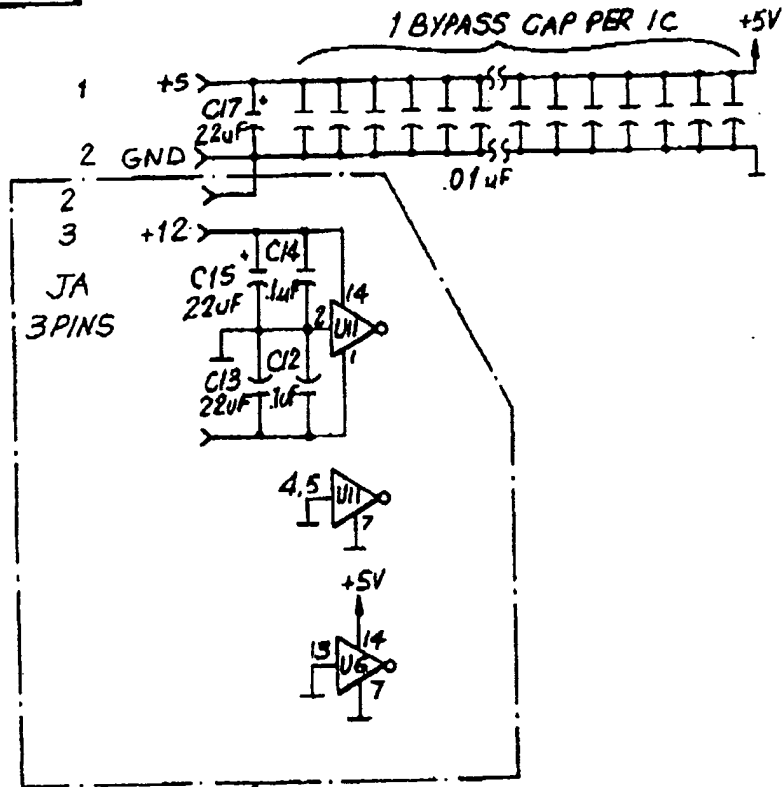

FIG. 4A

C1,3,4, 7-11,16,18 → 25
1 BYPASS CAP PER IC



SEE NOTE 5

U7	6809, MOTOROLA	MPU
U9	AMI 56516	16 STATIC RAM
U8	INTEL 2732 OR 2764	32K OR 64K E-PROM
U15	74LS 374	OCTAL D-LATCH
U16, U17	74LS 595	8BIT SHIFT REG.
U14	74LS 244	OCTAL BUFFER
U3	74LS137	3 BIT DECODER
U2	74LS 02	QUAD 2 IN NOR
U1	74LS 00	QUAD 2 IN NAND
U12, U13	74LS 74	DUAL D FLIP-FLOP
X1	4 MHZ	CRYSTAL

FIG. 4B

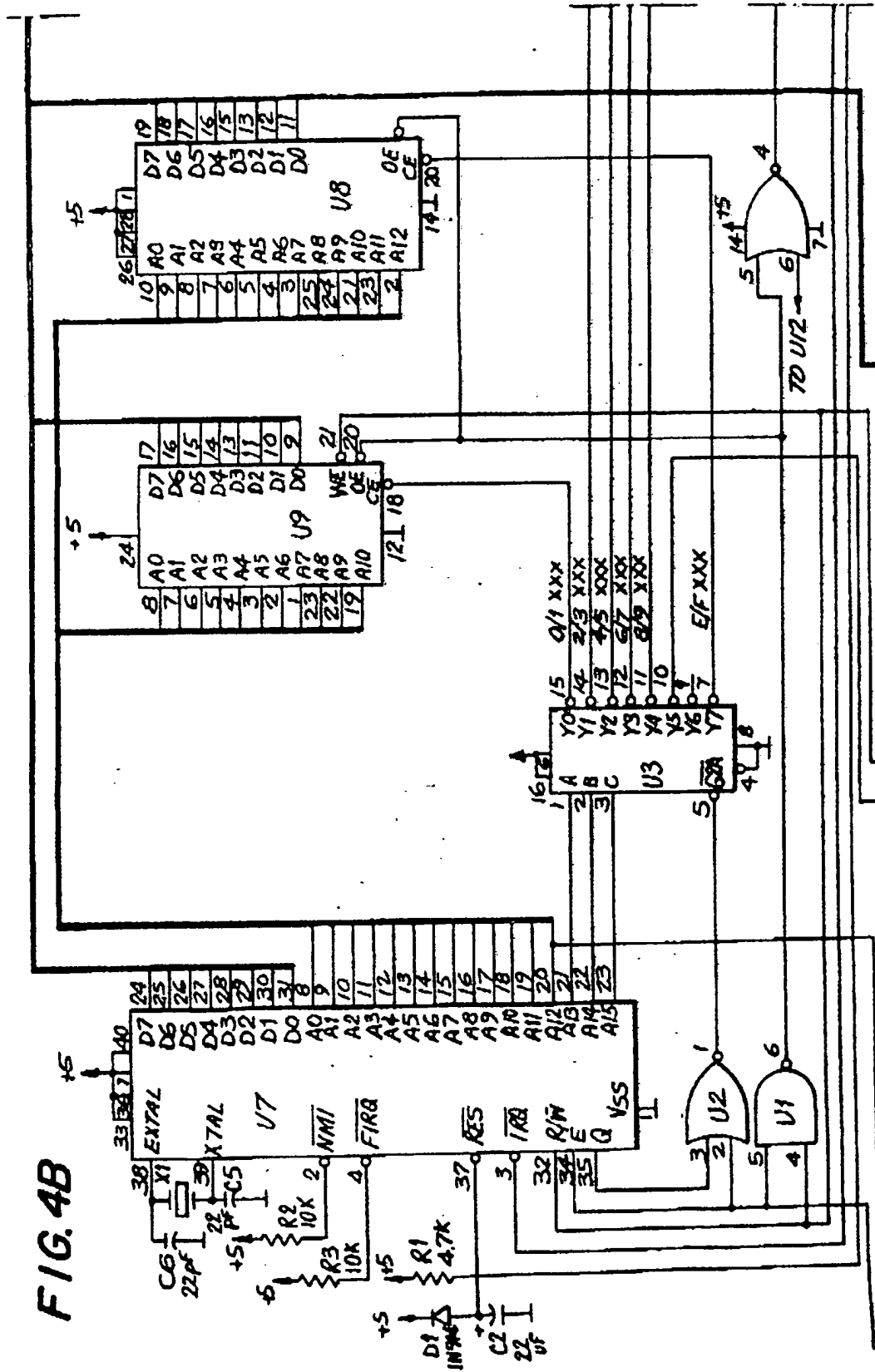

FIG. 4C

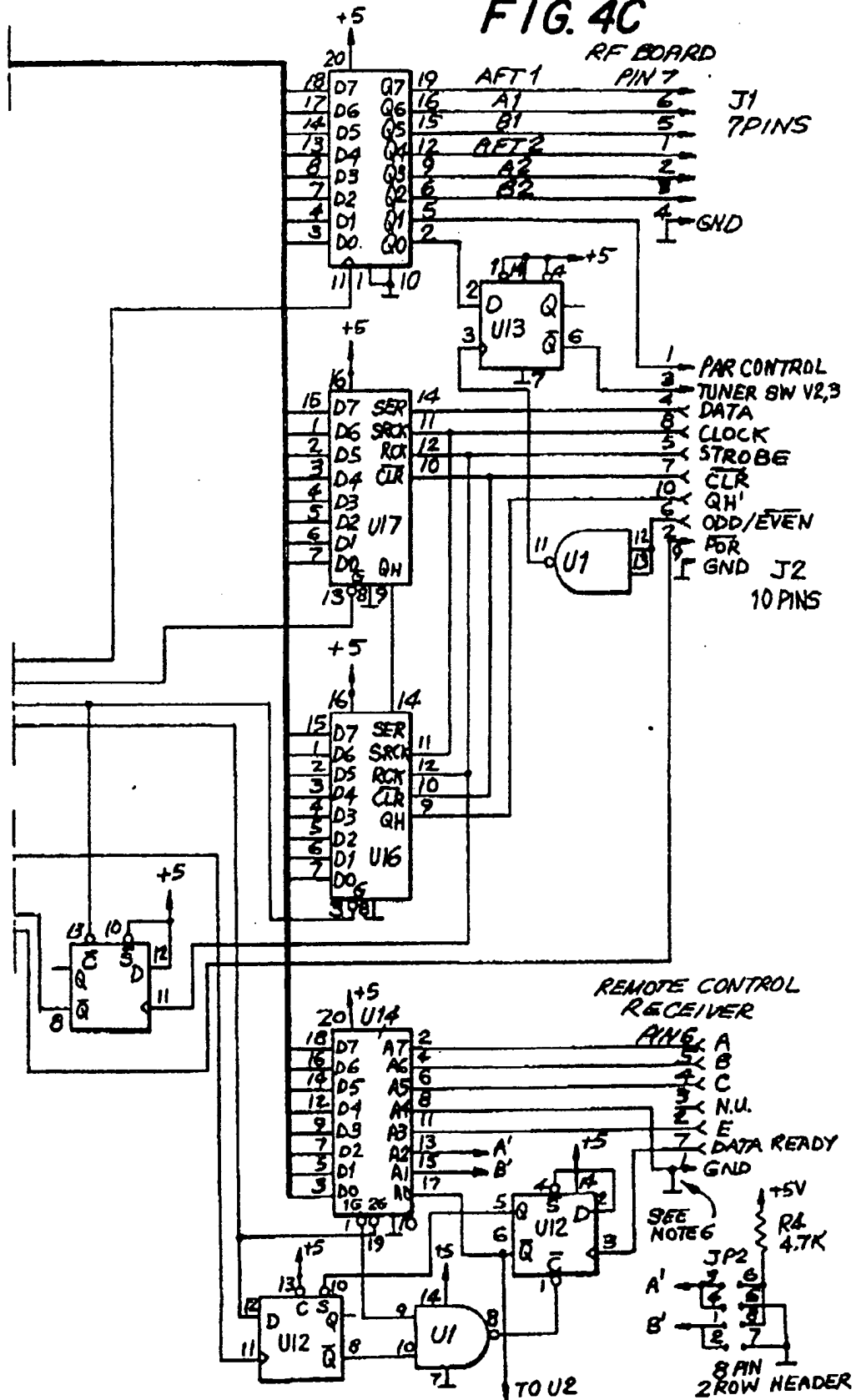
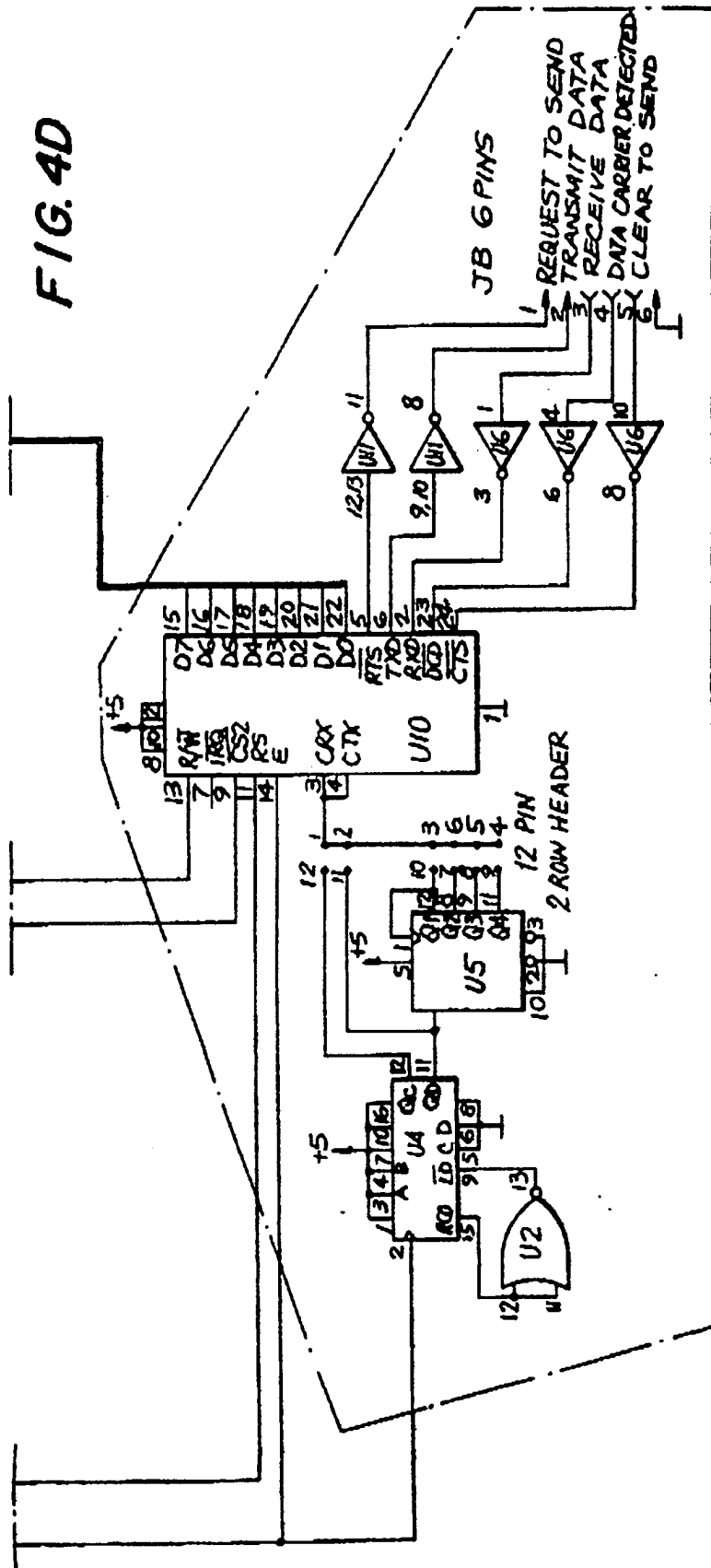

FIG. 4D



SEE NOTE 5

U4	74LS161	SYNCHRONOUS 4-BIT COUNTER
U10	6850	ACIA
U5	74LS93	4-BIT BINARY COUNTER
U11	1488	QUAD LINE DRIVER
U6	1489	QUAD LINE RECEIVER

40